

Briefing for the Buildings Energy Efficiency Ordinance (Cap. 610) and the BEC & EAC 2021 Edition

Energy Efficiency Office,
Electrical and Mechanical Services Department



Climate Action Plan 2050



The Hong Kong Special Administrative Region
of the People's Republic of China
The Chief Executive's 2021 Policy Address

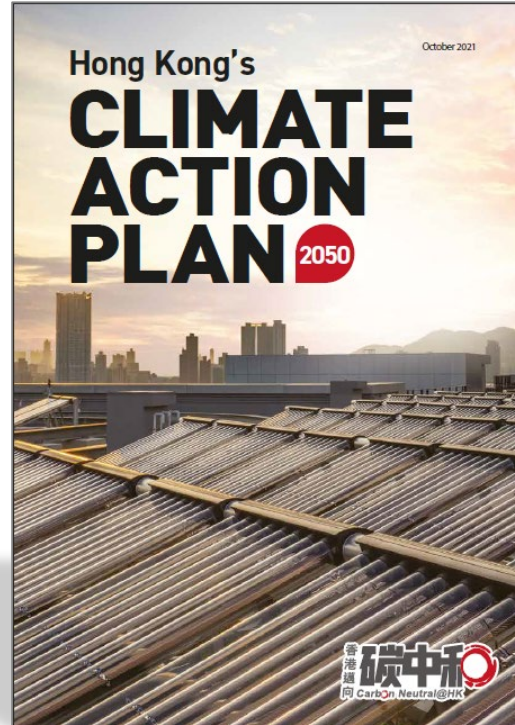

Four decarbonisation strategies

- Net-zero Electricity Generation**: Represented by a water drop icon with a crossed-out plug and a wind turbine.
- Energy Saving and Green Buildings**: Represented by a building icon.
- Green Transport**: Represented by icons for a person walking, a bicycle, and a car.
- Waste Reduction**: Represented by icons for recycling bins.

Before 2035

Before 2050

Total carbon emissions
Compared with 2005 level

50%

香港邁向 **碳中和**
Carbon Neutral@HK

2035

Electricity consumption (Compared with 2015)

COMMERCIAL BUILDINGS
15-20%

RESIDENTIAL BUILDINGS
10-15%

(Reduce by 30-40% subsequently)

(Reduce by 20-30% subsequently)

https://www.climateready.gov.hk/files/pdf/CAP2050_booklet_en.pdf

https://www.policyaddress.gov.hk/2021/eng/pdf/supplement_6.pdf

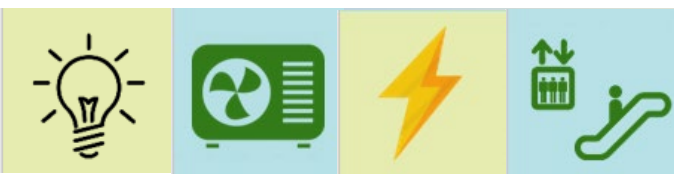

Hong Kong Situation



8,000+
Government
Buildings/
Facilities



42,000+
Buildings in
Private Sector



500+
New Buildings
per year



7.4 millions
Population

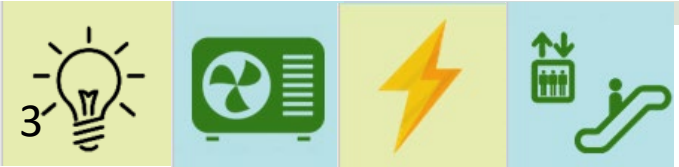
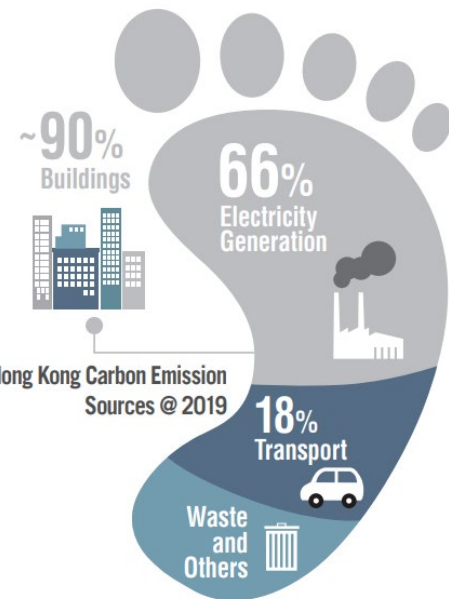

Source:
 1. Building Department, HKSAR
 2. Development Bureau, HKSARG
 3. Census and Statistics Department, HKSARG
 4. Climate Action Plan 2050, HKSARG

BEEO - Legislative Framework

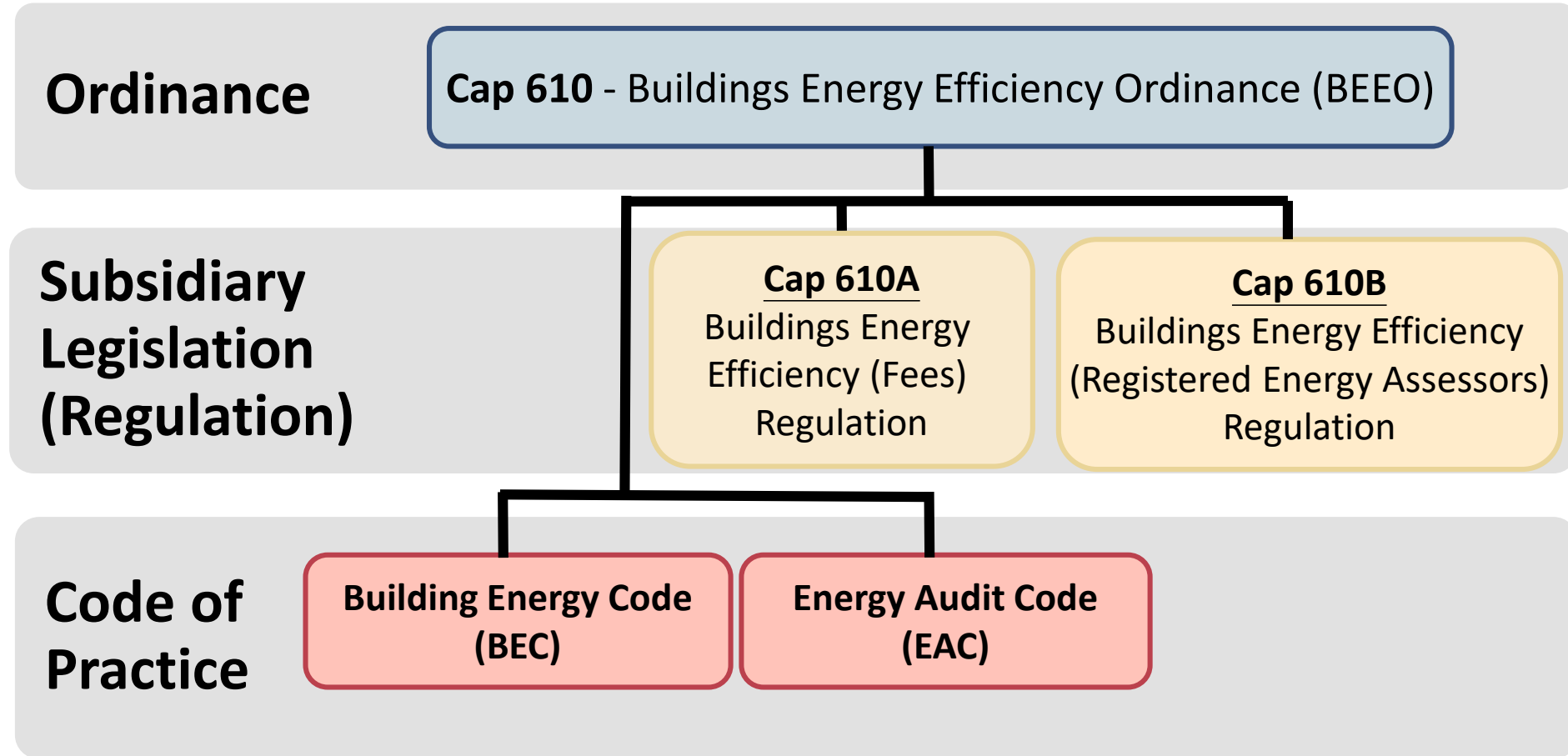

BEEO - Legislative Framework



✓ Full Implementation on 21 September 2012

4 types of Central Building Services Installation (CBSI)

The banner features the EMSD logo and the text 'Buildings Energy Efficiency Ordinance (Cap. 610)'. It highlights four key areas: Air-conditioning Installation, Lighting Installation, Electrical Installation, and Lift and Escalator Installation. The central text reads 'BUILDINGS ENERGY EFFICIENCY ORDINANCE (CAP. 610) 《建築物能源效益條例》第610章'. At the bottom, there are language options for English, 繁體中文, and 簡體中文, along with a QR code and the website URL <http://www.emsd.gov.hk/beeo>.

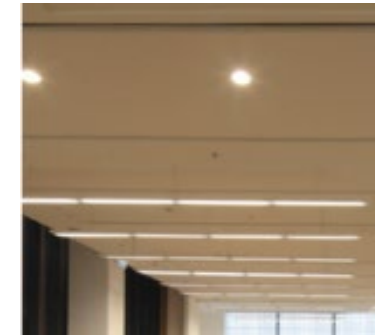

Lighting



Electrical

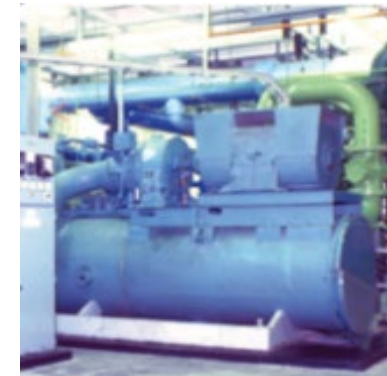

Air-conditioning



Lift & Escalator



BEEO - Legislative Framework



Cap 610 Schedule 1 COCR & FOC

- Hotel & guesthouse
- Educational building
- Community building (Social Service, Elderly Centers)
- Municipal services (Library, Indoor Game Hall, Market etc.)
- Hospital & clinic
- Government building
- Railway station
- Commercial building
- Industrial building – **common area**
- Residential building – **common area**
- Composite building –
 - (schedule 1) prescribed portion
 - **common area** of residential portion or industrial portion
- Airport passenger building

Cap 610 Schedule 3 Major Retrofitting Works

Works involving addition or replacement of a building services installation specified with

- ✓ Works area $\geq 500 \text{ m}^2$

and/or

Addition or replacement of a main component of a central building services installation (CBSI)

- ✓ Electrical Circuit $\geq 400\text{A}$
- ✓ A/C $\geq 350\text{kW}$
- ✓ **Motor drive & Mechanical drive** of a lift/ escalator/ passenger conveyor

Cap 610 Schedule 4 & 5 Energy Audit

- Commercial building
- Composite building (commercial portion)



BEEO – The 3 Major Requirement



	Responsible party	Applicability	Code Compliance	Legal Obligation
(1) Newly Constructed Buildings	Developer	4 key types of BSIs	BEC (Full)	Apply for COCR (EE1 & EE2)
(2) Existing Buildings	Responsible person; Owner of installation(s)	Major Retrofitting Works (MRW)	BEC (Partial) Table 10.1	Obtain FOC (EE4)
(3) Commercial Buildings / Commercial Portion of Composite Buildings	Building owner	Energy Audit	EAC Energy Audit Code	Obtain EA Form (EE5) and EA Report



(1) Newly Constructed Buildings



Stage One Declaration

- Developer engage **Registered Energy Assessor (REA)** to submit declaration **2 months after** obtaining Consent to commencement of building works (建築工程展開同意書)
- Declare the design of building services installations to comply with the BEC



Stage Two Declaration

- Developer engage **REA** to submit declaration **4 months after** the Occupation Permit (佔用許可證) is issued.
- Confirm **designed, installed and completed** BSIs complying with BEC
- Full fit-out works under developer's scope

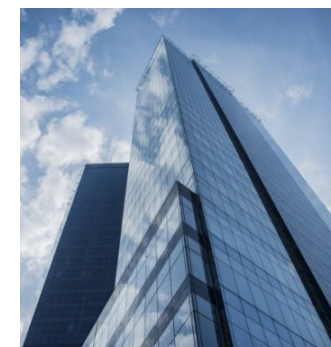

(2) Major Retrofitting Works in Existing Buildings



Works Area

Addition/replacement of a BS installation:

Works area $\geq 500 \text{ m}^2$ in a unit or a common area



Lighting – 3kW

Chiller, U-AC, AHU – 60kW

L & E – motor drive & mechanical drive

Central BS installation (CBSI)

Addition/replacement of **main component**:



electrical
circuit $\geq 400\text{A}$



A/C installation
 $\geq 350\text{kW}$

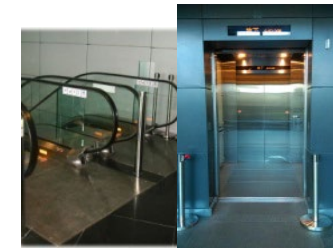

motor drive +
mechanical
drive



(2) Major Retrofitting Works in Existing Buildings

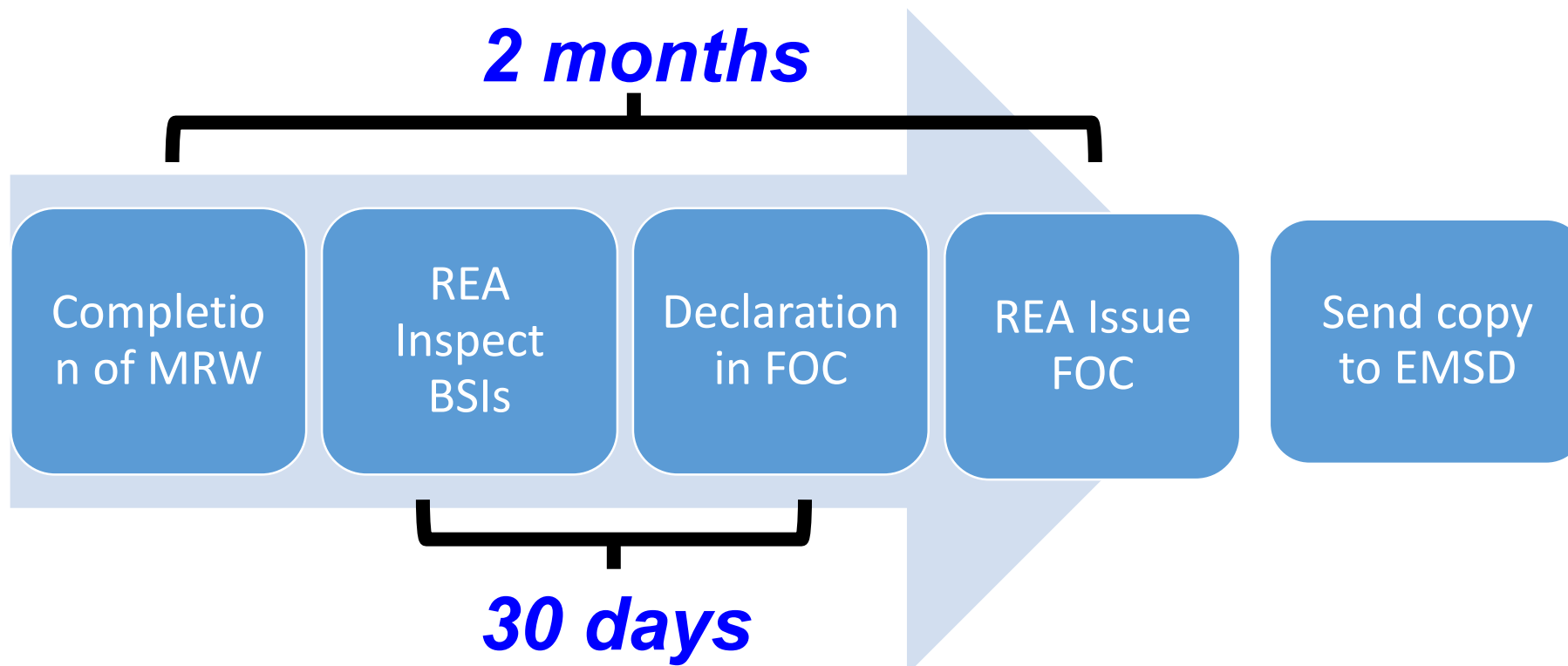



BEC 2021 & EAC 2021 Summary of Changes

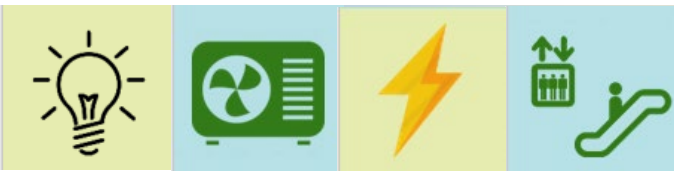

MBEC Technical Taskforce and Working Groups



Secretary for the Environment

Director of EMSD

Cap 610 - Buildings Energy Efficiency Ordinance (BEEO)

Building Energy Code (BEC)

Energy Audit Code (EAC)

Technical Taskforce and 6 Working Groups : 38 representative organizations

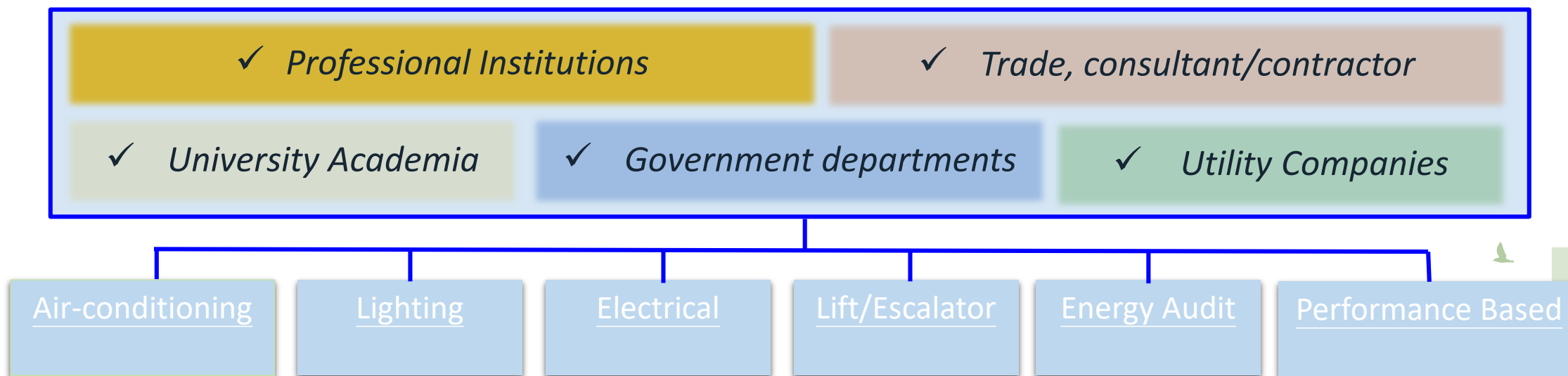

Review on the BEC & EAC 2021



- Making reference to:
 - a) **Maturity of latest technology** development;
 - b) Recognized **international standards** from other countries
 - c) *Data analysis from statutory submission*
 - d) *Aspiration from the public and stakeholders*

1) Uplifting on prevailing parameters
(e.g. Tighten the COP, LPD, motor efficiency)

2) Addition of new requirements
(e.g. LPD in new spaces, system control)

3) Widening & Amendment on BEEO requirements
(e.g. widening the coverage, more frequent energy audit)



Milestone of the BEEO

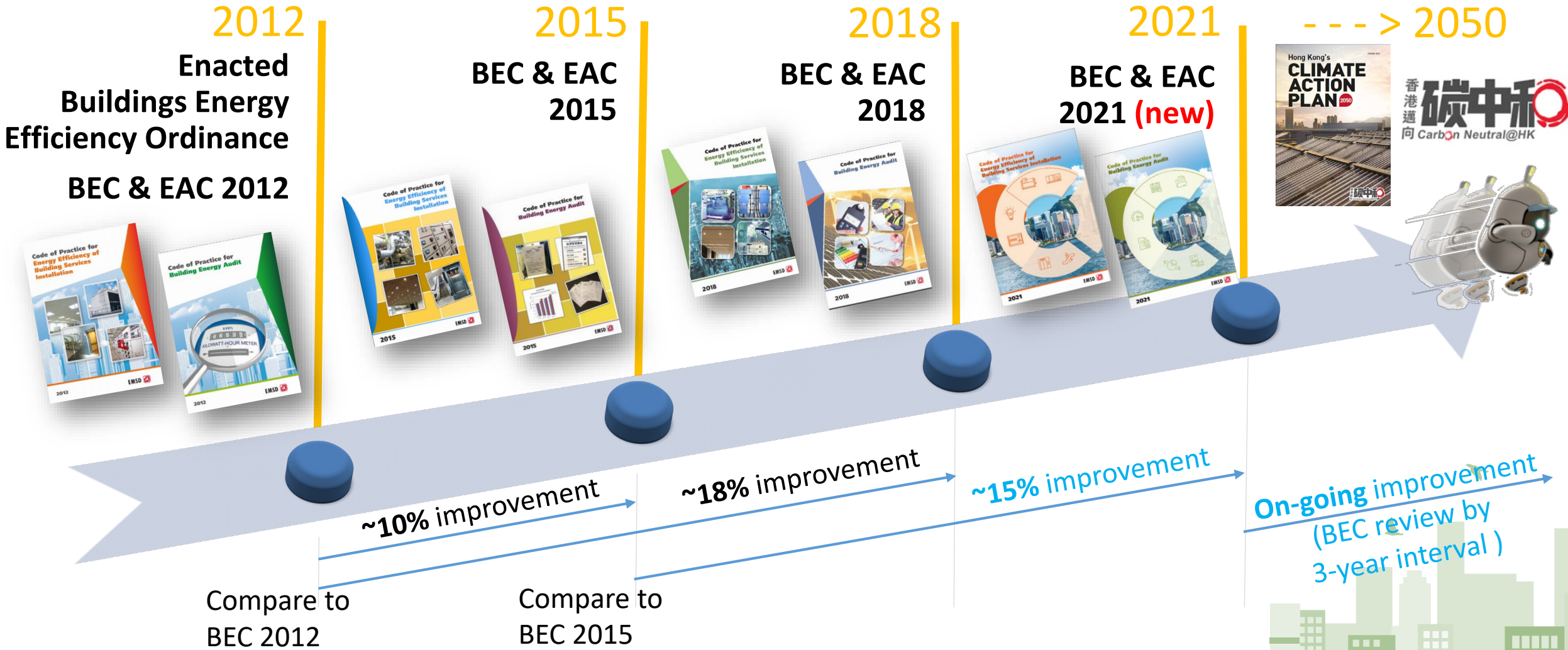

Changes on the BEC 2021



1. Lighting Installation
2. Air Conditioning Installation
3. Electrical Installation
4. Lift & Escalator Installation
5. Performance-based Approach



Lighting Installation (Section 5)



Highlights of Major Changes

Lighting Installation

LPD requirement covers new spaces

LPD requirement of certain spaces tightened

More spaces to include automatic lighting control (ALC)

Tightening ALC requirement
(i.e. activation time shorten from 15 mins to 10 mins for carpark)

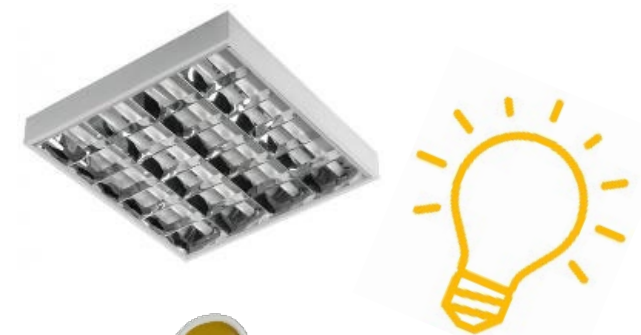

Lighting Installation (Section 5)



Table 5.4 LPD Requirement Covers New Spaces

Type of spaces	BEC 2021 LPD (W/m ²)
Activity Room / Children play area / Music Room / Recreational facilities room	9.5
Baby care room / Breastfeeding room	9.7
Medical examination room	15.0
Pharmacy area	17.0
Report Room (Police Station)	8.9
Security Room / Guard Room	9.0
Spa Room / Massage Room	13.0



Lighting Installation (Section 5)



Table 5.4

LPD Requirement of Certain Spaces Tightened

Type of Spaces	BEC 2018 (W/m ²)	BEC 2021 (W/m ²)	% Changed
Canteen	11	9.5	-13.64
Car Park	5	4.0	-20.00
Classroom / Training Room	12	9.1	-24.17
Computer Room / Data Centre	15	12.5	-16.67
Conference / Seminar Room	14	12.8	-8.57
Corridor	8	7.0	-12.50
Dormitory	8	6.2	-22.50
Entrance Lobby	13	11.5	-11.54

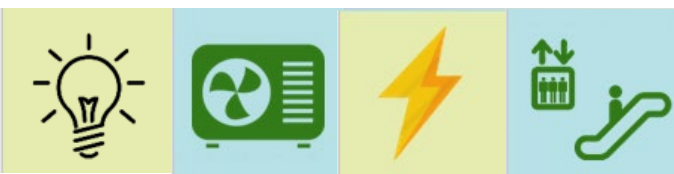

Lighting Installation (Section 5)



Table 5.4

LPD Requirement of Certain Spaces Tightened

Type of Spaces	BEC 2018 (W/m ²)	BEC 2021 (W/m ²)	% Changed
Guest room in Hotel or Guesthouse	13	11.5	-11.54
Gymnasium / Exercise Room	11	9.5	-13.64
Kitchen	13	11.5	-11.54
Laboratory	15	13.5	-10.00
Lift Lobby	10	9.2	-8.00
Office, enclosed (Internal floor area ≤15m ²)	12	9.5	-20.83
Office, open plan or with internal floor area 15m ² < A ≤ 200m ²	10	8.9	-11.00
Office, open plan or with Internal floor area >200m ²	9	7.8	-13.33



Lighting Installation (Section 5)



Table 5.4

LPD Requirement of Certain Spaces Tightened

Type of Spaces	BEC 2018 (W/m ²)	BEC 2021 (W/m ²)	% Changed
Pantry	12	10.2	-15.00
Plant Room / Machine Room / Switch Room (≤ 15m ²)	10	9.5	-5.00
Plant Room / Machine Room / Switch Room (>15 m ²)		8.8	-12.00
Public Circulation Area	13	11.5	-11.54
Restaurant	17	13.6	-20.00
Retail	16	13.4	-16.25
School Hall	14	12.5	-10.71

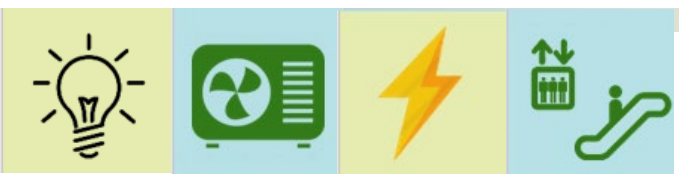

Lighting Installation (Section 5)



Table 5.4

LPD Requirement of Certain Spaces Tightened

Type of Spaces	BEC 2018 (W/m ²)	BEC 2021 (W/m ²)	% Changed
Server Room / Hub Room	10	8.9	-11.00
Staircase	7	6.0	-14.29
Storeroom / Cleaner	9	7.9	-12.22
Toilet / Washroom / Shower Room	11	9.7	-11.82
Workshop	13	11.5	-11.54

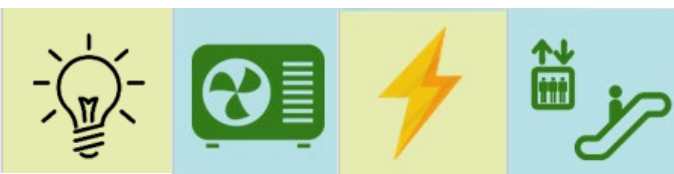

Lighting Installation (Section 5)



Table 5.4

More spaces to include the requirement of automatic lighting control

Type of Spaces	BEC 2018	BEC 2021
Exhibition Hall / Gallery	No	Yes
Library – Stack Area	No	Yes
Library – Reading Area or Audio Visual Centre	No	Yes
Activity Room / Children play area / Music Room / Recreational facilities room	-	Yes
Baby care room / Breastfeeding room	-	Yes



Automatic Time Scheduling



Occupancy Sensor

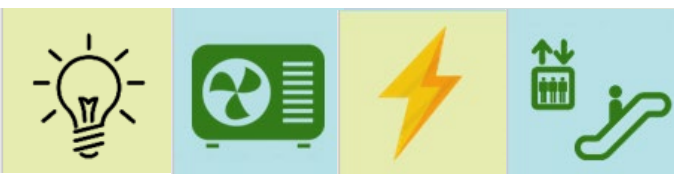

Lighting Installation (Section 5)



Tightening carpark ALC requirement

Clause No.	Tightened Requirement
5.6.1.5	For space deploying occupant sensors, the reduced lighting power control should activate within 15 minutes (<u>10 minutes for carpark</u>) of all occupants leaving the space.



Occupancy Sensor



Air-conditioning Installation (Section 6)



Highlights of Major Changes

Air-conditioning

The AC equipment efficiency tightened

Expanding the requirement of variable flow of chilled water pumping system

Including chilled water temperature reset control requirement & provision for chiller plant > 350kW



Air-Conditioning Installation (Section 6)



The AC equipment efficiency tightened

<i><u>Tightening Requirement</u></i>	<i><u>Elaborated / New Requirement</u></i>
Room air conditioner	Fulfill the requirements of Energy Efficiency Grade 1 or Grade 2 specified in the Code of Practice on Energy Labelling of Products 2020
Unitary Air-conditioners	Please refer to the tables on the next few slides for the detail amendment
Variable Refrigerant Flow System (VRF)	
Chillers	
Heat pumps	



Air-Conditioning Installation (Section 6)



Table 6.12a Min. COP of Unitary Air-conditioner

	BEC 2018	BEC 2021	% Changed
Air-cooled (cooling mode):	2.6 for split type 2.3 for non-split type (7.5 kW or below)	2.7 for split type 2.5 for non-split type (7.5 kW or below)	3.85 (split type) 8.7 (non-split type)
	2.5 (Above 7.5 kW to 200 kW)	2.65 (Above 7.5 kW to 200 kW)	6.0
Air-cooled (heating mode)	2.7 (7.5 kW or below)	2.8 (7.5 kW or below)	3.7



Air-Conditioning Installation (Section 6)



Table 6.12a Min. COP of VRF System

	BEC 2018	BEC 2021	% Changed
Air-cooled (cooling mode): Single unit of side-discharge fan(s)	/	3.6 (20 kW or below)	/
		3.6 (Above 20 kW)	/
Air-cooled (cooling mode): Modular unit of top-discharge fan(s)	3.6 (20 kW or below)	3.9 (20 kW or below)	8.33
	3.6 (Above 20 kW to 40 kW)	3.9 (Above 20 kW to 40 kW)	8.33
	3.45 (Above 40 kW to 200 kW)	3.7 (Above 40 kW to 80 kW)	7.25
		3.5 (Above 80 kW to 200 kW)	1.45
	3.3 (Above 200 kW)	3.4 (Above 200 kW)	3.03



Air-Conditioning Installation (Section 6)



Table 6.12a Min. COP of VRF System

	BEC 2018	BEC 2021	% Changed
Air-cooled (heating mode): Single unit with side-discharge fan(s)	/	4.0 (20 kW or below)	/
		3.8 (Above 20 kW)	/
Air-cooled (heating mode): Modular unit with top-discharge fan(s)	4.0 (20 kW or below)	4.3 (20 kW or below)	7.5
	3.8 (Above 20 kW to 40 kW)	4.1 (Above 20 kW to 40 kW)	7.89
	3.8 (Above 40 kW to 200 kW)	4.0 (Above 40 kW to 80 kW)	5.26
	3.6 (Above 200 kW)	3.8 (Above 80 kW to 200 kW)	0
		3.7 (Above 200 kW)	2.78



Air-Conditioning Installation (Section 6)



Table 6.12a Min. COP of VRF System

	BEC 2018	BEC 2021	% Changed
Water-cooled (cooling mode)	4.5 (All Ratings)	4.6 (All Ratings)	2.22
Water-cooled (heating mode)	4.8 (All Ratings)	4.9 (All Ratings)	2.08



Refrigerant Side

Water Side

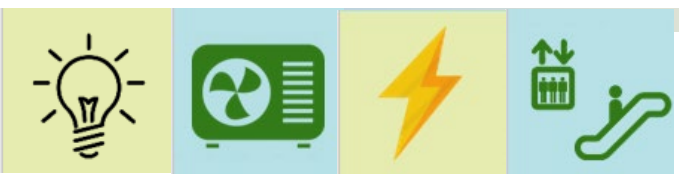
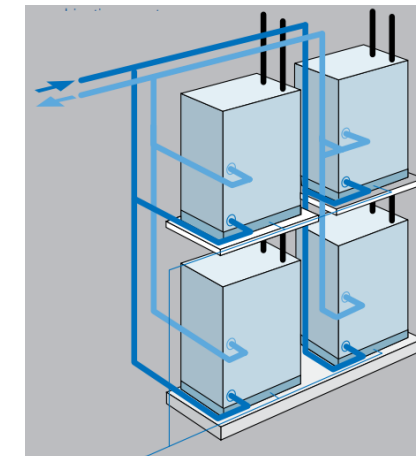

Air-Conditioning Installation (Section 6)



Table 6.12b

Min. Allowable COP of Air-Cooled Chiller

Air-Cooled Chiller		BEC 2018	BEC 2021	% Changed
Scroll	Below 400 kW	2.8	2.9	3.57
	At & Above 400 kW	2.9	3.0	3.45
Screw	Below 500 kW	3.0	3.1	3.33
VSD Screw	Below 500 kW	3.0 (3.8 at 75% load)	3.1 (3.9 at 75% load)	3.33 (2.63)
	At & Above 500 kW	3.9 at 75% load	4.0 at 75% load	2.56

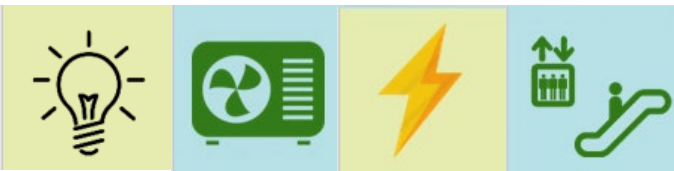

Air-Conditioning Installation (Section 6)

Table 6.12b - Min. Allowable COP of Water-Cooled Chiller

Water-Cooled Chiller		BEC 2018	BEC 2021	% Changed
Reciprocating /Scroll	< 500 kW	4.2	4.3	2.38
VSD Screw	< 500 kW	4.7	4.8	2.13
	500 to 1,000 kW	4.9 (6.7 at 75% load)	5.0 (6.8 at 75% load)	2.04 (1.49)
	> 1,000 kW	7.0 at 75% load	7.2 at 75% load	2.86
Centrifugal	> 3,000 kW	5.8	5.9	1.72
VSD Centrifugal	< 1,000 kW	5.3 (7.0 at 75% load)	5.4 (7.2 at 75% load)	1.89 (2.86)
	1,000 to 3,000 kW	5.6 (7.5 at 75% load)	5.7 (7.7 at 75% load)	1.79 (2.67)
	> 3,000 kW	5.8 (7.6 at 75% load)	5.9 (7.8 at 75% load)	1.72 (2.63)



Air-Conditioning Installation (Section 6)



Table 6.12b Minimum COP of Heat Pump

Heat Extract	BEC 2018	BEC 2021	% Changed
Capacity: Above 500 kW	3.1 (Air-to-water)	3.2 (Air-to-water)	3.23

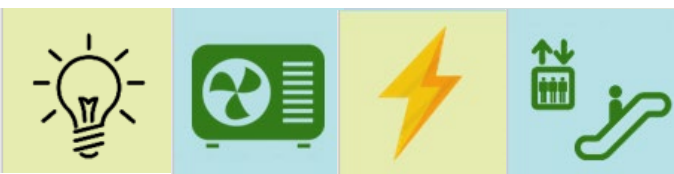

Air-Conditioning Installation (Section 6)



Expanding the requirement of variable flow of chilled water pumping system

Clause No.	Tightened Requirement
6.8.1	A water side pumping system”should be capable of reducing system flow to 50-25% of design flow or less” by sequencing on and off of multiple chillers and pumps or by reduced speed operation of variable speed pump, except -
6.8.2	A chilled water pump, with motor output power exceeding 3.7-2.2kW , serving a variable flow system as prescribed in clause 6.8.1 should incorporate controls and devices such that the pump motor demands no more than 30% of design input power at 50% of design water volume flow.

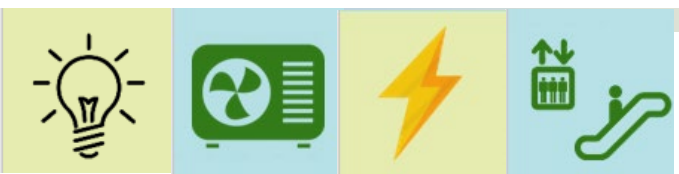
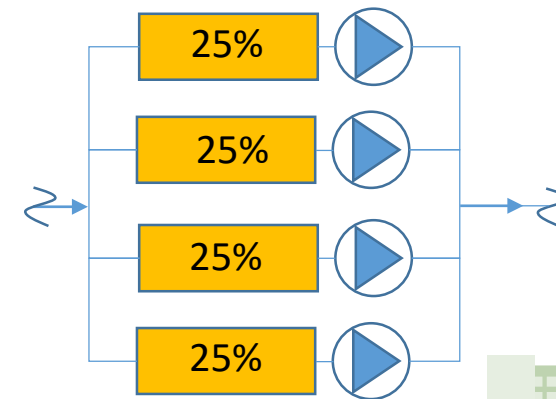
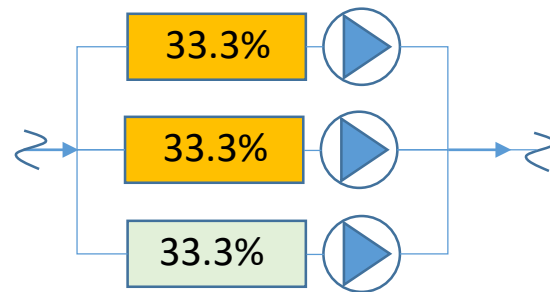
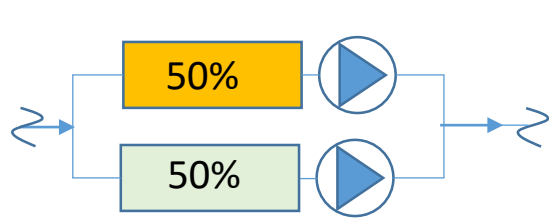

Air-Conditioning Installation (Section 6)



Detail explaining the requirement of off-hour control in Guest / Hotel room

Clause No.	Tightened Requirement
6.10.4.3	Each guest room or suite with multiple rooms should be provided with a single master control device to reduce energy use during un-occupied periods. The master control device should be able to - (a) turn off or reduce the conditioned air supply to a minimum; or (b) reset the temperature setting to <u>raise at least 2°C from the cooling mode setpoint / to lower at least 2°C from the heating mode setpoint to reduce energy use; or</u> (c) reset the temperature setting together with reduction of fan speed.

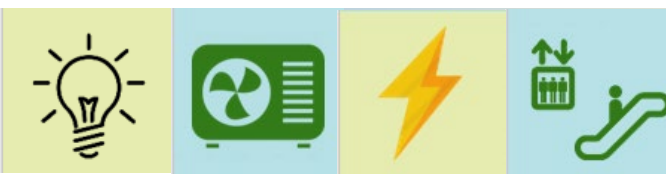
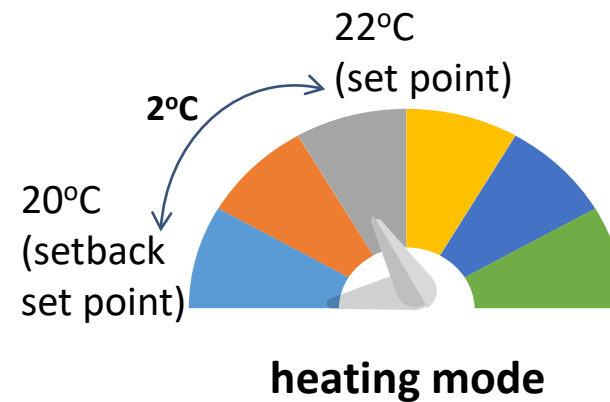
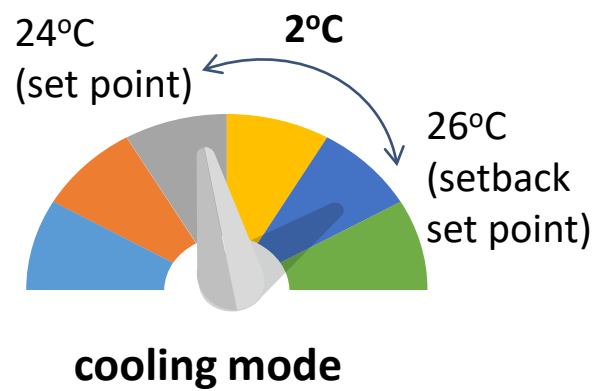

Air-Conditioning Installation (Section 6)



Including metering of chilled water pump(s)

Clause No.	Tightened Requirement
6.13.1 & 6.13.2	<p>A chiller, heat pump or unitary air-conditioner, of 350 kW or above cooling/heating capacity,..... A chilled/heated water plant, of 350kW or above cooling/heating capacity.....</p> <p>should be equipped with continuous monitoring facilities to measure its power (kW) & energy (kWh) input, cooling/heating power (kW) (by measuring water temperature and flow for chiller and heat pump) & energy (kWh) output and coefficient of performance</p>
6.13.3	<p>In determining a chilled water plant's power & energy input, the inputs to all equipment for producing the cooling output, such as chiller compressors, circulation pumps of chillers, condensers or cooling towers, condenser fans, cooling tower fans, radiator fans etc. should be included, <u>whereas the inputs to chilled water pumps should be excluded.</u> Likewise for a heated water plant, the inputs to all equipment for producing the heating output, such as heat pump compressors, circulation pumps on heat input and output side of water source heat pumps, fans of air source heat pumps, boilers or hot water heaters etc. should be included , <u>whereas the inputs to chilled water pumps should be excluded.</u></p>



Air-Conditioning Installation (Section 6)



Including chilled water temperature reset control requirement & provision for chiller plant > 350kW

Clause No.	Tightened Requirement
6.15.1	<u>Chilled water plant of 350kW or above cooling capacity supplying chilled water for comfort cooling shall be equipped with controls that automatically reset supply water temperatures by representative building loads or by outdoor air temperature.</u>

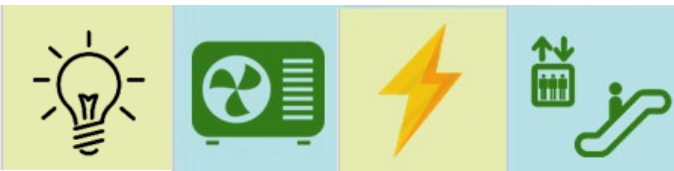

Electrical Installation (Section 7)



Separate metering for charging facilities for EV

Clause No.	New / Elaborated Requirement
7.7.3.1	<p>Circuit serving each of the following installation should be incorporated with metering devices separately,</p> <ul style="list-style-type: none"> (a) entire chilled water plant, (b) entire heated water plant, (c) all lifts, and (d) all escalators or passenger conveyors <u>(e) all charging facilities for electric vehicles.</u> <div style="display: flex; justify-content: space-around; align-items: center;"> <div data-bbox="377 878 631 1235"> <p>Hong Kong ROADMAP ON POPULARISATION OF ELECTRIC VEHICLES</p> </div> <div data-bbox="637 878 1184 1235"> <p style="color: red; font-weight: bold;">No new registration of fuel-propelled private cars including hybrid vehicles in 2035 or earlier</p> </div> <div data-bbox="1189 878 1567 1235"> </div> </div>

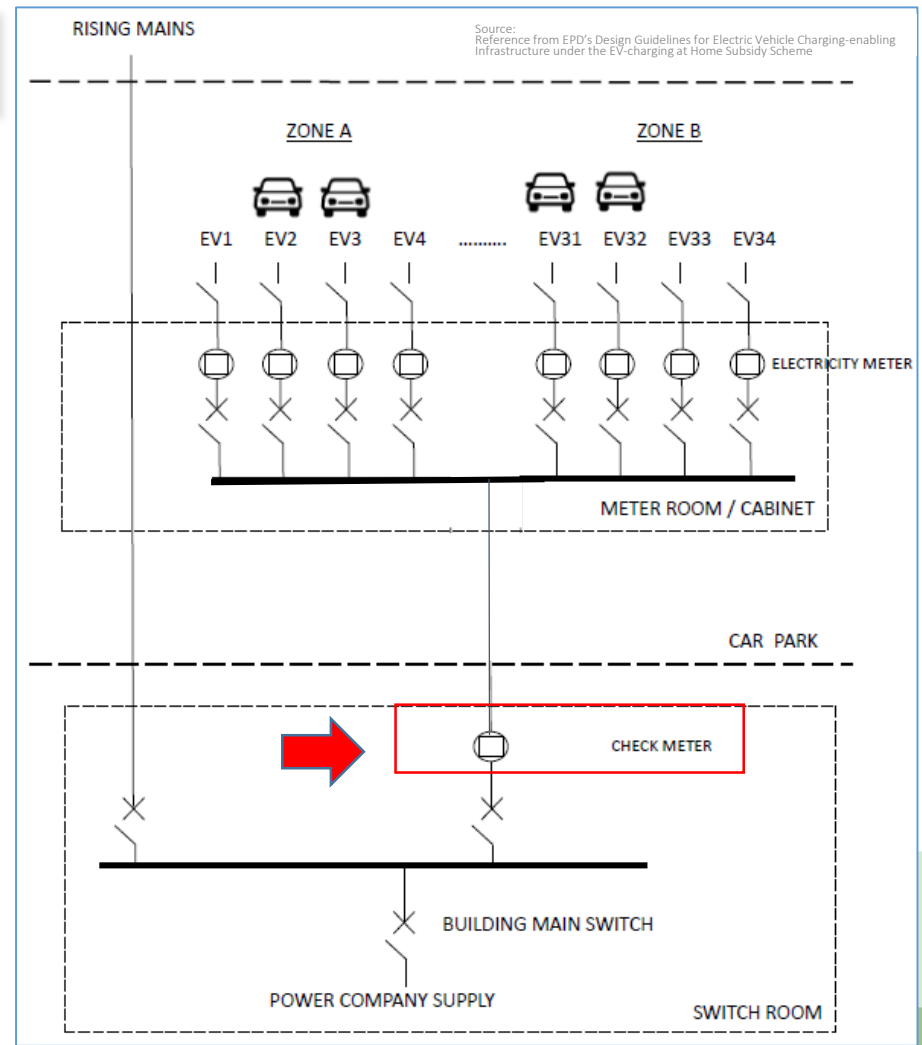

Source: Reference from EPD's Design Guidelines for Electric Vehicle Charging-enabling Infrastructure under the EV-charging at Home Subsidy Scheme

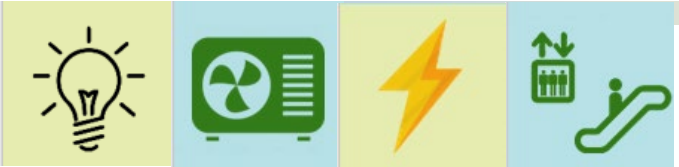

Lift & Escalator Installation (Section 8)



Lift Installation

Max. allowable electrical power of traction lift with rate speed $< 4\text{m/s}$ (Table 8.4.1a&b) **↓ 10 %**

Max. allowable electrical power of traction lift with rate speed $\geq 4\text{m/s}$ to $< 9\text{m/s}$ (Table 8.4.1b&b) **↓ 5 %**

Max. allowable electrical power of escalator/passenger conveyor - **No tighten**
(minor amendment on equation at Table 8.4.3 & 8.4.4)

Max. allowable lift decoration load (Table 8.5.2) **↓ 10 %**



Reduction on max. electrical power input



Less weight on lift decoration



Lift & Escalator Installation (Section 8)



Updating the requirement of lift regeneration with rated speed of 2 m/s or above and rated load at 900kg or above.

Clause No.	New / Elaborated Requirement
8.5.5	<p>Lift Regenerative Braking</p> <p>Regenerative braking should be provided for each of a lift -</p> <p>(a) with rated speed of 2.5 m/s 2.0 m/s or above, and</p> <p>(b) rated load at 1000 kg 900 kg or above.</p> <p>The power from the regenerative braking should be fed towards the incoming source of the driving controller.</p>

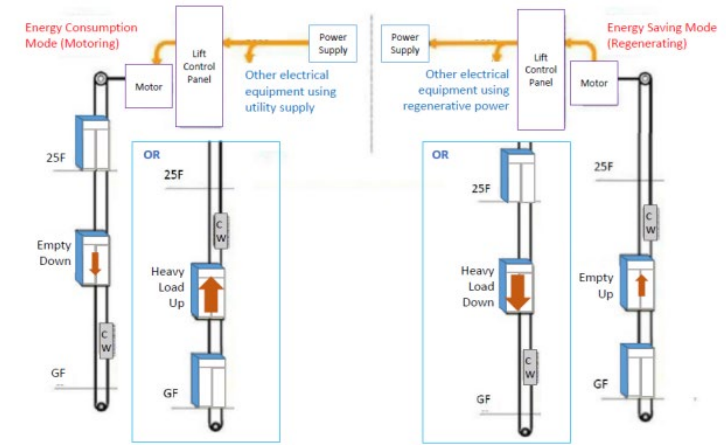

Lift regenerative Braking



Performance-based Approach (Section 9)



Relax the boundary of trade-off percentage from prescriptive requirement to 25%

Clause No.	New / Elaborated Requirement
9.4.2	The energy efficiency performance of the trade-off should not exceed 15% 25% lower than the corresponding prescriptive requirement given in Section 5 to 8 of this BEC.
9.4.3	The following trade-off items should not exceed 20% lower than the corresponding prescriptive requirement. – Lighting Power Density – Air distribution System Fan Power

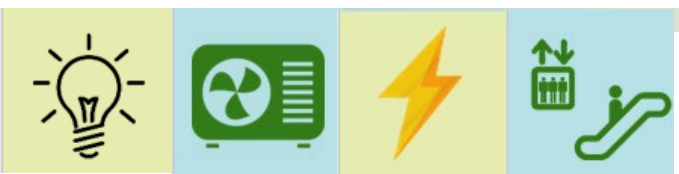
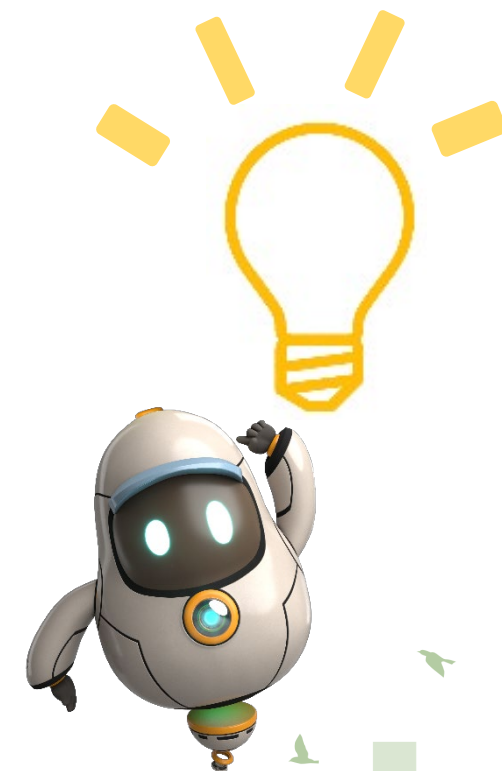

Performance-based Approach (Section 9)



Baseline of Building Design for Trade-off in Design Energy revised

Clause No.	New / Elaborated Requirement
9.5.4.3	The items or installations involved in the trade-off process should be under the same ownership except for building with the cooling source from a remote plant or a service provider of district cooling system.

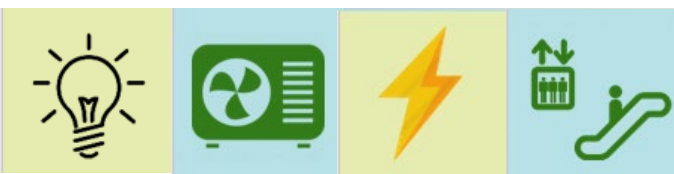
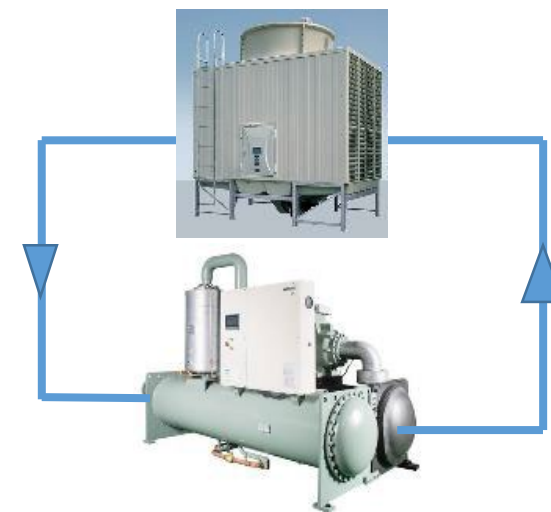

Changes on the EAC 2021



Major Changes

Separation of Electricity consumption under charging Facilities of electric vehicles
- Clause 7.3.1

Reporting on chiller plant efficiency data and possible EMO for chiller plant optimization based on any in-situ metering facilities or BMS available data
- Clause 7.3.2

Review the execution of EMO and comparison of EUI with previous EA report
- Clause 7.3.1
- Clause 7.4.1
- Clause 8.1



EAC Clause 7.3 - Review of Energy Consuming Equipment



Separation of Electricity consumption for Charging Facilities of EV

Clause No.	EAC 2021
7.3.1	<p>Study the information collected and conduct site inspections for an appreciation of the applicable energy consuming equipment and systems of the central building services installations. Based on the findings in the study and inspections, compile records of the characteristics of the energy consuming equipment and systems including –</p> <p><u>(j) energy consumption by charging facilities of electric vehicles through separated metering;</u></p>

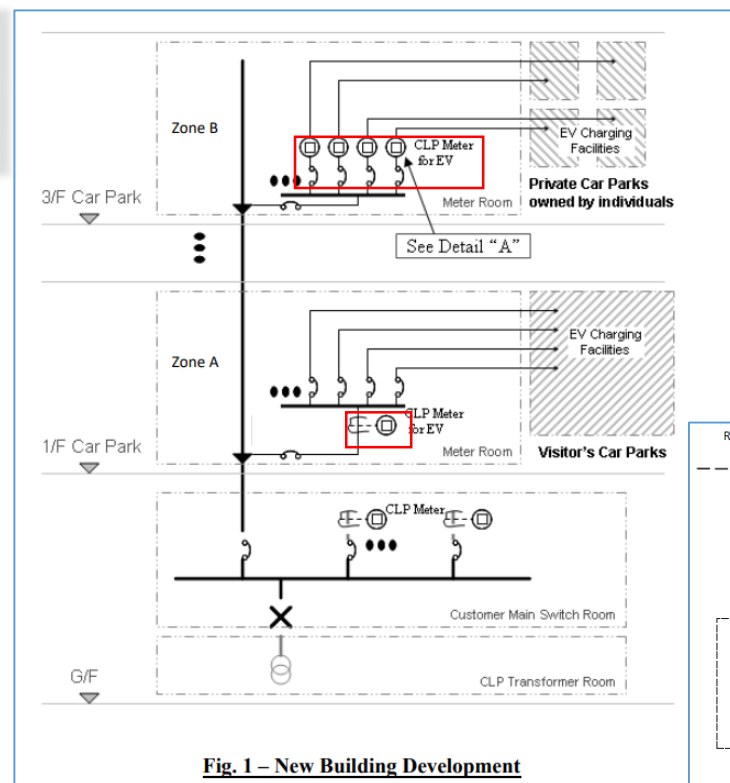
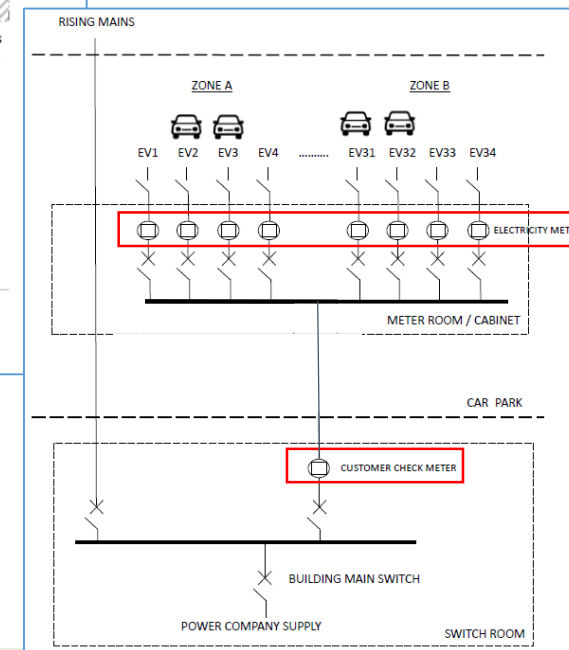
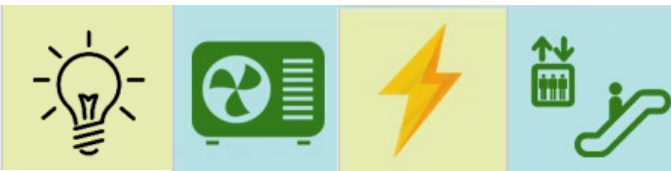

Fig. 1 – New Building Development



Source:
 1. Guide to Supply and Metering Arrangement on Customer's Internal Distribution System, CLP
 2. Reference from EPD's Design Guidelines for Electric Vehicle Charging-enabling Infrastructure under the EV-charging at Home Subsidy Scheme.



EAC Clause 7.3 - Review of Energy Consuming Equipment



Reviewing the performance data of chillers and data of total power factor and total harmonic distortion based on any in-situ metering facilities or BMS available data

Clause No.	EAC 2021
7.3.2	<p><u>(d) Based on any in-situ metering facilities or BMS available data, identify and calculate the energy efficiency of the chiller with cooling capacity of 350kW or above. The energy efficiency values can be calculated based on the data collected by existing monitoring equipment such as temperature sensor, flow meter, energy meter etc.</u></p> <p><u>(e) Based on any in-situ metering facilities or BMS available data, identify and calculate the total power factor and total harmonic distortion for the electrical circuits</u></p>

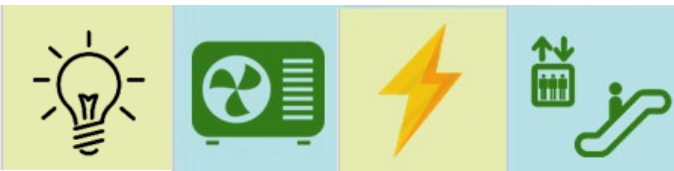

EAC Clause 7.4 – Identification of EMO



Evaluation of the progress on implementation and energy performance of EMOs

Clause No.	EAC 2021
7.3.1	Study the information collected and conduct site inspections for an appreciation of the applicable energy consuming equipment and systems of the central building services installations. Based on the findings in the study and inspections, compile records of the characteristics of the energy consuming equipment and systems including – <u>(m) implementation progress and status of Energy Management Opportunities (EMOs) suggested in previous energy audit(s).</u>
7.4.1	Based on the findings in clause 7.3, an evaluation and appraisal should be conducted on the energy consuming equipment/systems, focusing on their energy performances against their corresponding operating conditions <u>and EMO(s) implemented in respect of previous energy audit(s),</u> including but not limiting to – <u>(g) energy performance of the EMO(s) implemented in respect of previous energy audit(s); and</u> (h) EUI of the building



EAC Clause 8.1 – Information for Report



Evaluation of the progress on implementation and energy performance of EMOs

Clause No.	EAC 2021
8.1	<p>The following information should be included in the report -</p> <ul style="list-style-type: none">(a) energy audit scope, including –<ul style="list-style-type: none">- a summary of the installations, equipment and systems audited;- a summary of the assumptions and estimating methods supplementing any non-availability of data essential to the determination of EUI; and- <u>a comparison between the EUIs of current and the previous energy audit and explanation of the differences</u>...(g) analysis of historical energy consumption of the building, including –...vi) <u>comparison between the EUI of the previous energy audit and the EUI in ii). (this energy audit)</u>...(m) <u>energy consumption and performance evaluation of EMO(s) implemented in respect of pervious energy audit(s);</u>

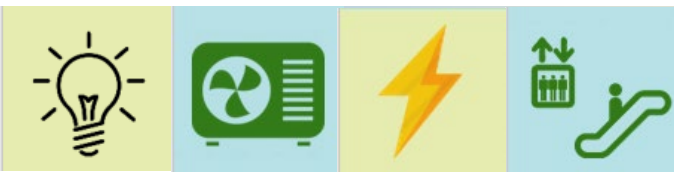

Gazette Date and Grace Period



BEC 2021

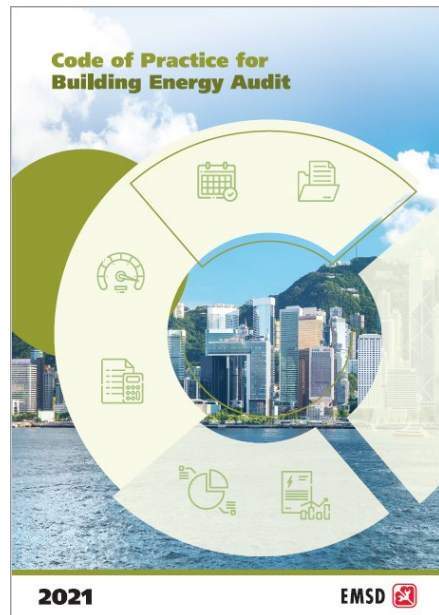

EAC 2021

Gazette Date: 31 December 2021

Technical Circular Ref.: 1/2021

Submission	Effective Date For complying with BEC/ EAC 2021
Stage One Declaration (6-month Grace Period)	1 July 2022 <i>(Signed by the developer and received by EMSD on or after 1 July 2022)</i>
Form of Compliance (9-month Grace Period)	1 October 2022 <i>(Signed by the REA and received by EMSD on or after 1 October 2022)</i>
Energy Audit (9-month Grace Period)	1 October 2022 <i>(Signed by the REA and received by EMSD on or after 1 October 2022)</i>

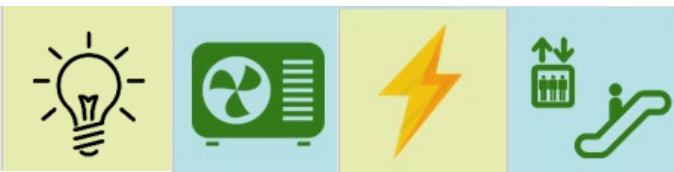



Misunderstanding on BEEO requirements (Sharing on previous cases)

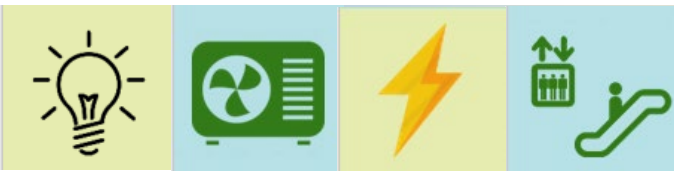

ALC Requirement for 24-hour Operation



ALC requirement on lighting space with 24-hour operation vs 24-hour occupied
(BEC Clause 5.6.1.6)



Entrance Lobby

[Only the security counter is 24-hr occupied & ALC is NOT applicable]

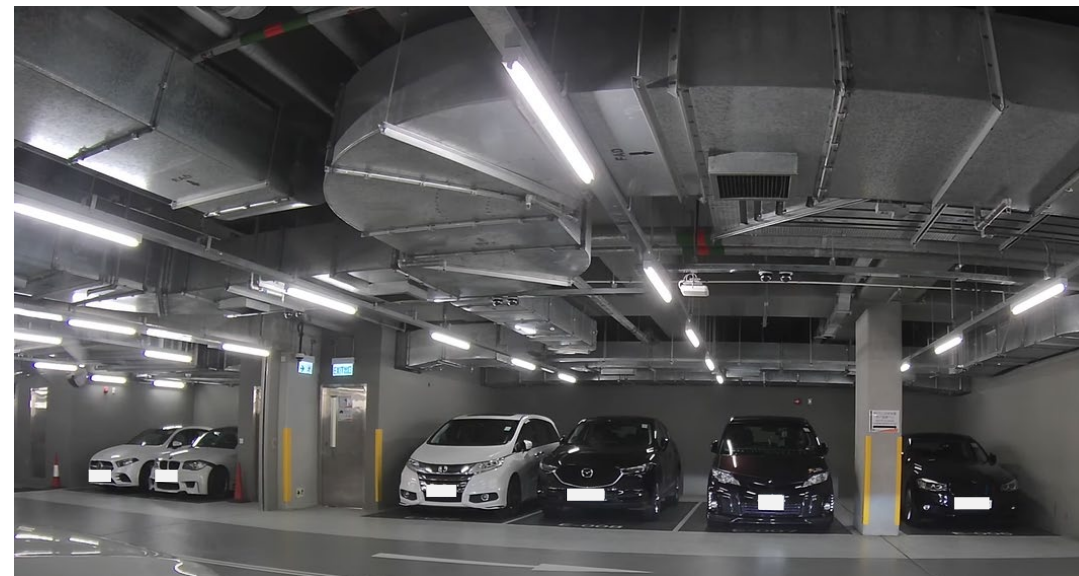

Carpark (day & night parking) – operate 24-hr

[NOT equal to 24-hr occupied and ALC is applicable]

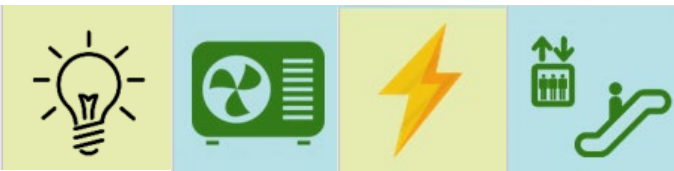

Considerations on Special Lighting & Decorative Lighting



Special lighting under Schedule 2 and separate switch with other general lighting

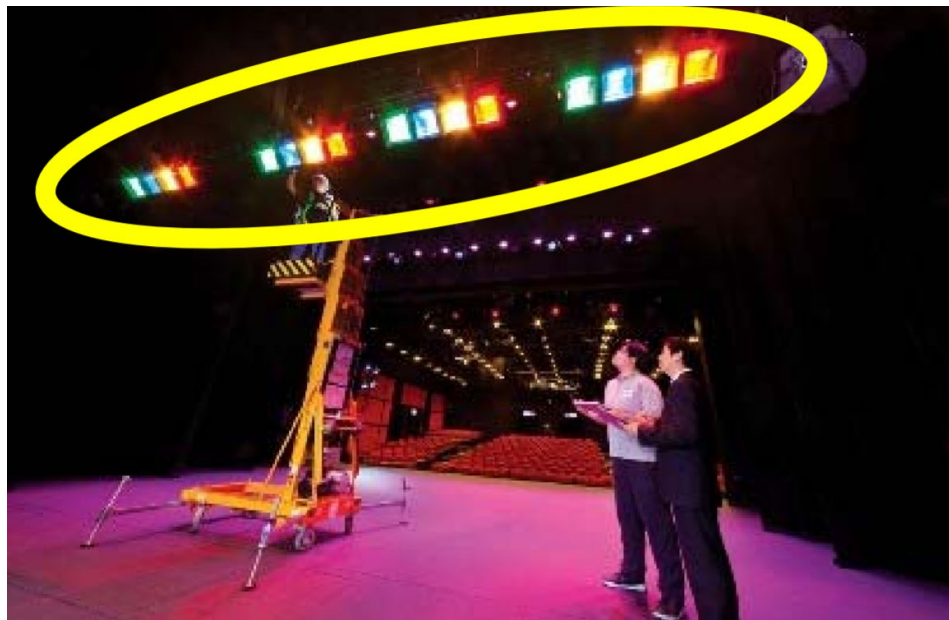

Stage Lighting solely for performance
[BEEO NOT applicable]

[fulfilling item 6(c), Schedule 2 of the Ordinance]

Separate circuit with general lighting

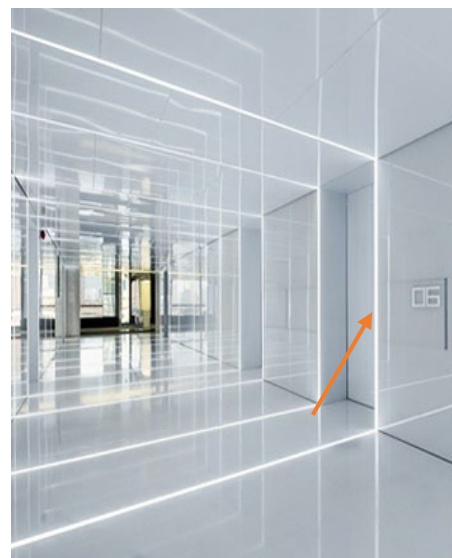

Feature lighting contributed as general lighting
[BEEO governed]



Dual Purpose Ventilation Fans



Fans not solely for the purposes of fire suppression

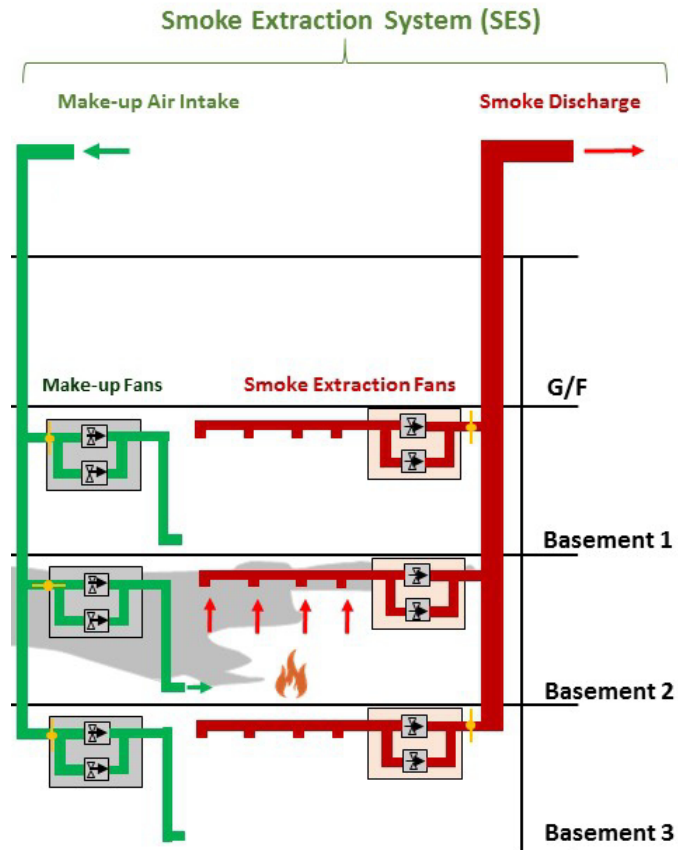

Fans solely for fire suppression purpose
[BEE0 NOT applicable]

If fans are designed for dual purpose in
normal operation and fire situation
[BEE0 applicable]
[Details refer to BEC clause 6.1.2(a)]



Coverage of BEEO on Declared Monuments



Declared Monuments Vs Graded Historic Buildings

Grading System of Historic Buildings	Monument Declaration System
Administrative	Statutory
Antiquities Advisory Board	Antiquities and Monuments Ordinance (Cap 53)
Grade 1; Grade 2; Grade 3	Declared monument; Proposed monument
Objective basis for determining the heritage value	Statutory Protection
BEEO Applicability → Schedule 1	BEEO NOT Applicable

Declared Monuments in Hong Kong

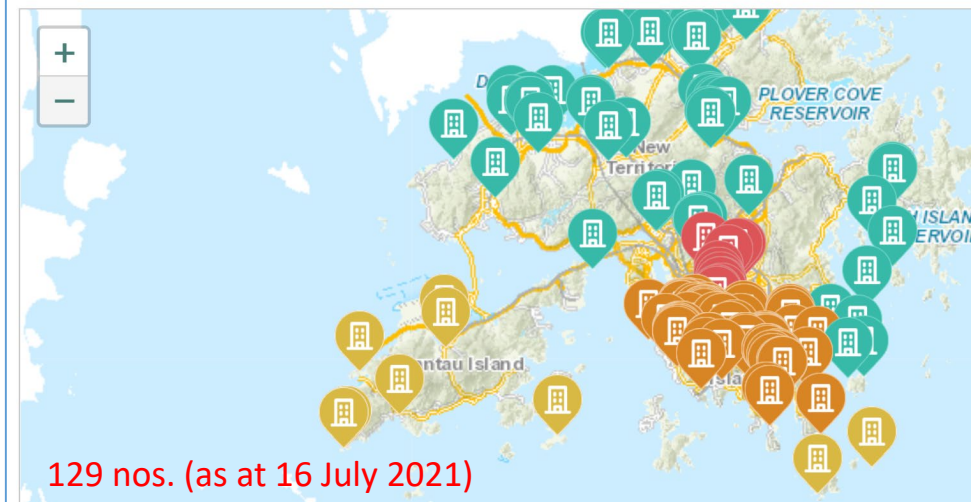

<https://www.amo.gov.hk/en/historic-buildings/monuments/index.html>

Section:	4	Limit of scope of application	E.R. 1 of 2013	25/04/2013
----------	---	--------------------------------------	----------------	------------

- (1) This Ordinance does not apply to—
- (d) a monument or a historical building declared under section 3 of the Antiquities and Monuments Ordinance (Cap 53).

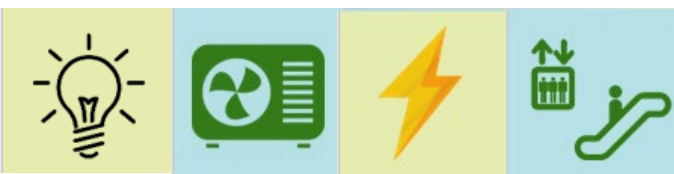
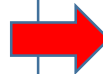

Further Information



<http://www.emsd.gov.hk/beeo>



EMSD Buildings Energy Efficiency Ordinance (Cap. 610)

BUILDINGS ENERGY EFFICIENCY ORDINANCE (CAP. 610)
《建築物能源效益條例》第610章

空調裝置
Air-conditioning Installation

電力裝置
Electrical installation

照明裝置
Lighting installation

升降機及自動梯裝置
Lift and escalator Installation

English 繁體中文 簡體中文



<https://www.youtube.com/watch?v=rxi7jVWbCQo>

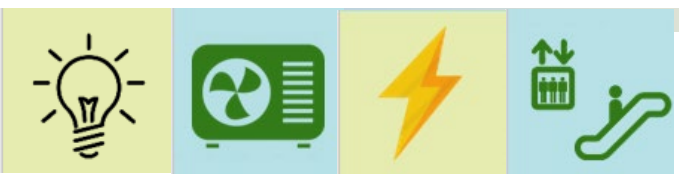

Further Information

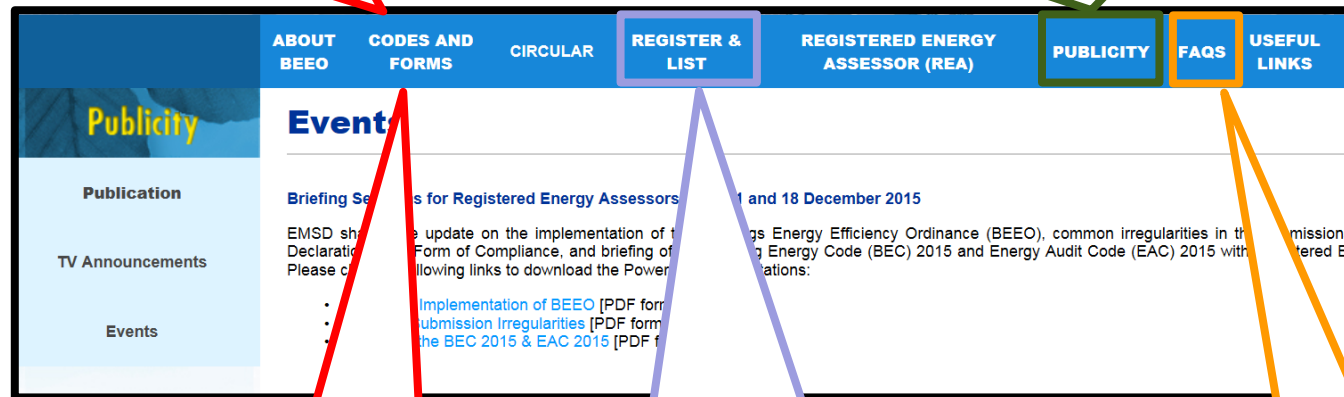
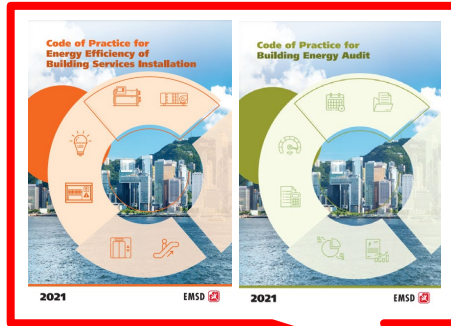

- Specified Forms
- Technical Forms
- Technical Guidelines

- Register of REA and COCR
- List of Stage One Declaration, FOC, EA Form and IN

- Frequently Asked Questions

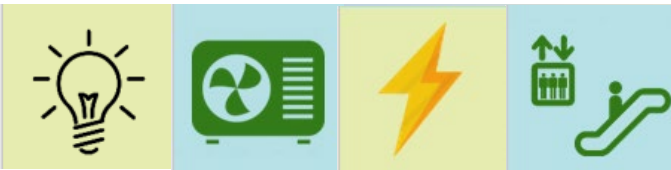

香港力爭2050年前實現碳中和

HK will strive to achieve carbon neutrality before 2050



香港力爭2050年前實現碳中和
HK will strive to achieve carbon neutrality before 2050



Q&A

